

IDS SA
ATL
SC

SOUTHERN DISTRICT
DESIGN CONFERENCE

RE(CONNECT)



IDS SA

INDUSTRIAL DESIGNERS SOCIETY OF AMERICA

Southern District Student Merit Award - Graduate Winner 2026

EBUBE MADUKA-UGWU
GEORGIA TECH M.I.D INDUSTRIAL DESIGN

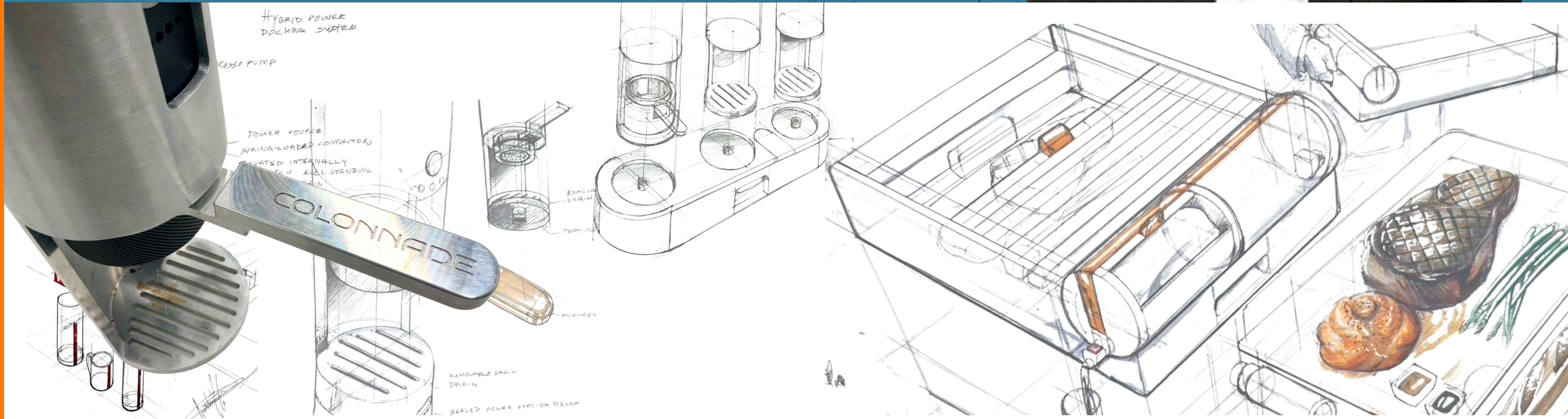



rexq

ODYSSEY

FLOOD RESCUE VEST

Modular rescue vest enabling hands-free evacuation during flash floods.

THE PROBLEM



Chongqing Municipality, July 4, 2023



Hunan Province, July, 2024



Pingjiang county, Hunan Province, July 2, 2024



- Observation of flood rescues shows responders often carry children while navigating unstable water.
- This limits their ability to stabilize themselves, operate equipment, and safely navigate the environment
- Rescuers need **both hands free** to navigate and lead vulnerable victims to safety.



DEVELOPMENT

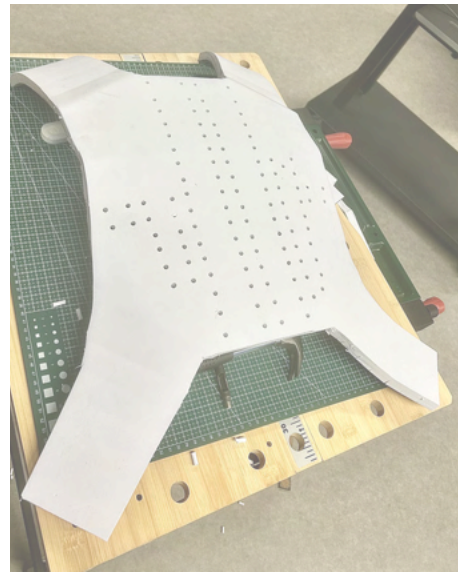
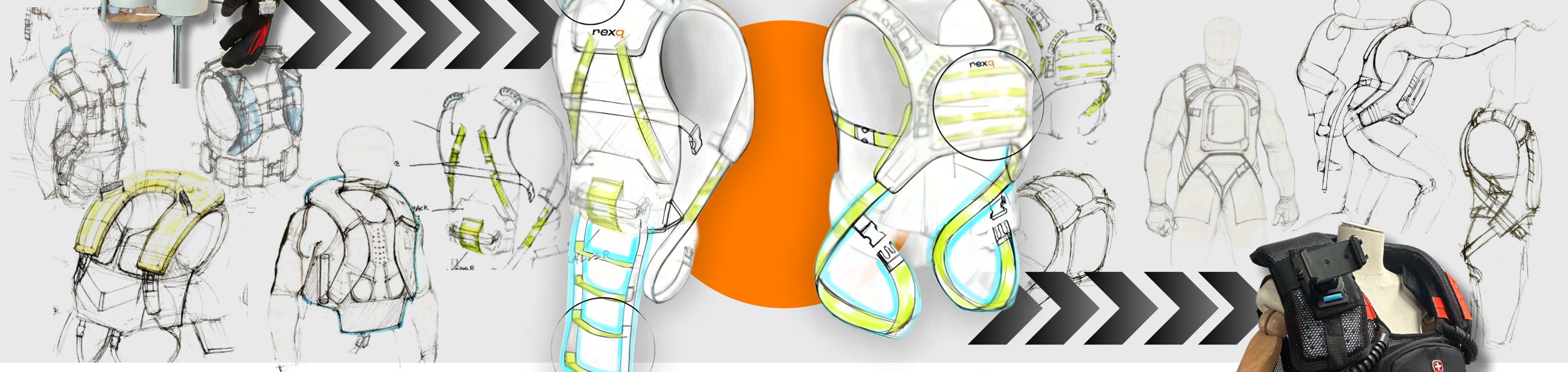

FRONT HANDLES
TO HOLD ON TO RESCUER

BACK HANDLES
FOR SECURE CLIMB
ONTO THE VEST

DETACHABLE STEP LADDER

- CAN BE STORED AWAY INSIDE FRONT POUCH
- DISCHARGEABLE IF STUCK IN DEBRIS
- HEAVY-DUTY SIDE RELEASE BUCKLE FOR STRENGTH WHEN CLIMBING OR DISCHARGE AT WILL.

GAS-ACTIVATED INFLATABLE
AQUA STRETCHER & INFANT
CARRY

- STORED INSIDE FRONT POUCH OF THE VEST
- DEPLOYABLE FOR INJURED VICTIMS
- FRONT CARRIER FOR CHILDREN UNDER 5

ON THE MOVE

Sequence illustrates retrieval, deployment, and secure transport of rescued victims.

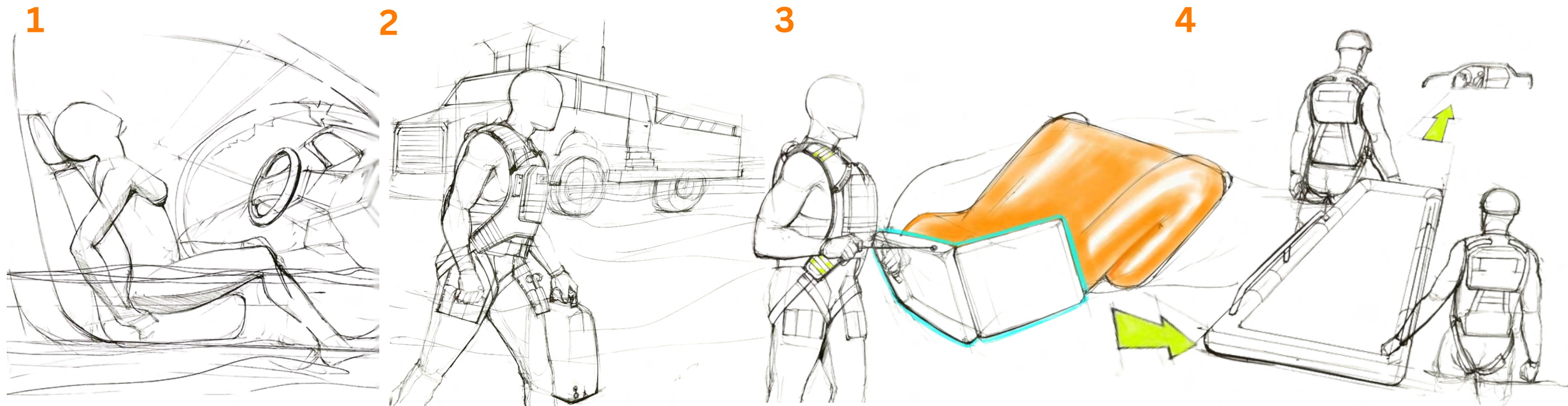

COLOR • MATERIAL • FINISH

REXQ ORANGE:
HEX CODE: F77203

- ✓ • CLOSED-CELL HIGH BUOYANCY FOAM CORE
- ✓ • BREATHABLE, HEAVY-DUTY POLYESTER MESH (OVER THE FOAM)
- ✓ • WATERPROOF ZIPPER RESCUE POUCH
- ✓ • REFLECTIVE SAFETY FABRIC
- ✓ • WATERPROOF WEBBING



DESIGN FOR MANUFACTURING

TITLE: TORSO VEST FRONT
 CONTACT PERSON: Ebube Maduka Ugwu PHONE NUMBER: +86 171 5032 6335 EMAIL: ebsymku@gmail.com DATE: 2024/10/6

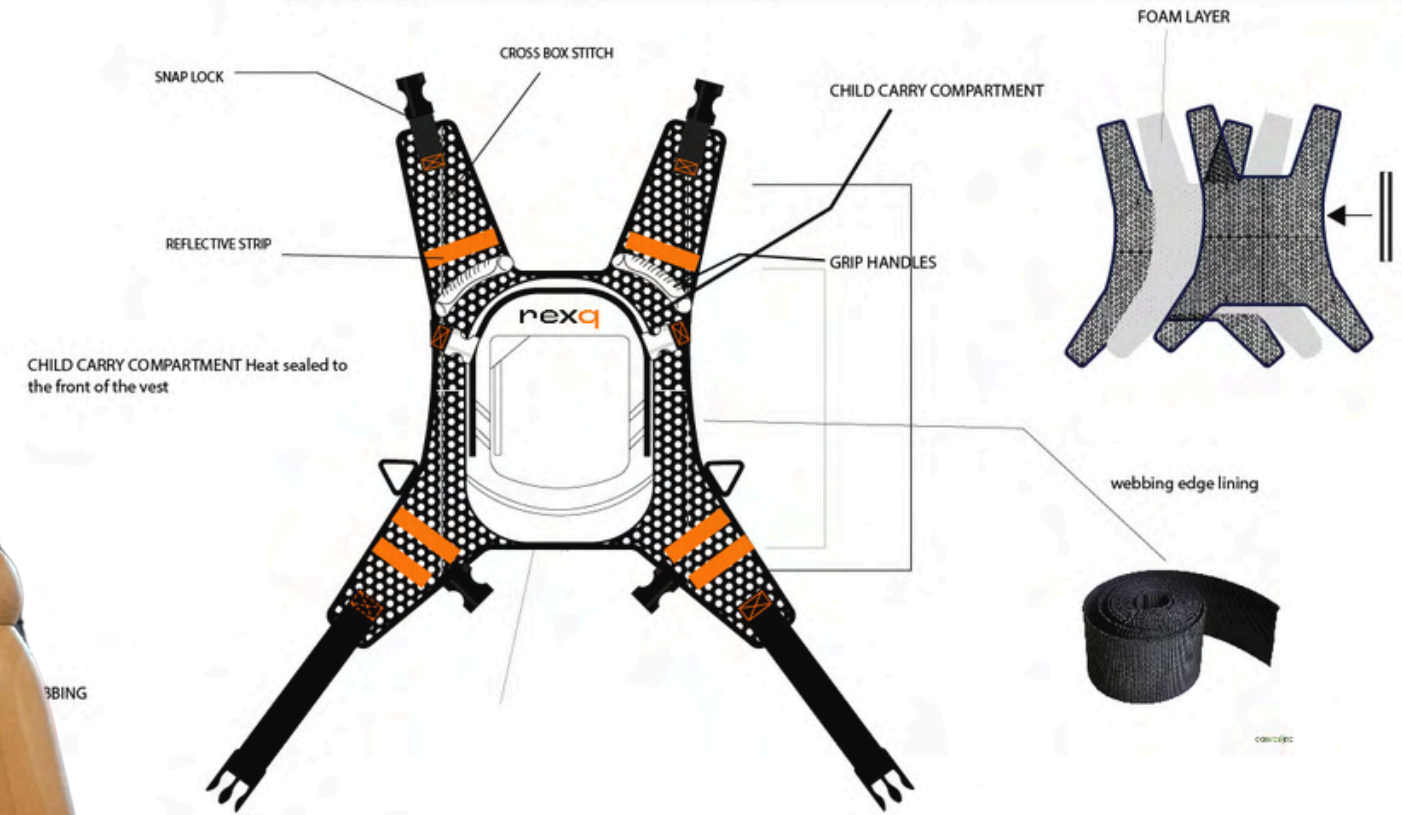

TITLE: TORSO VEST BACK
 CONTACT PERSON: Ebube Maduka Ugwu PHONE NUMBER: +86 171 5032 6335 EMAIL: ebsymku@gmail.com DATE: 2024/10/6

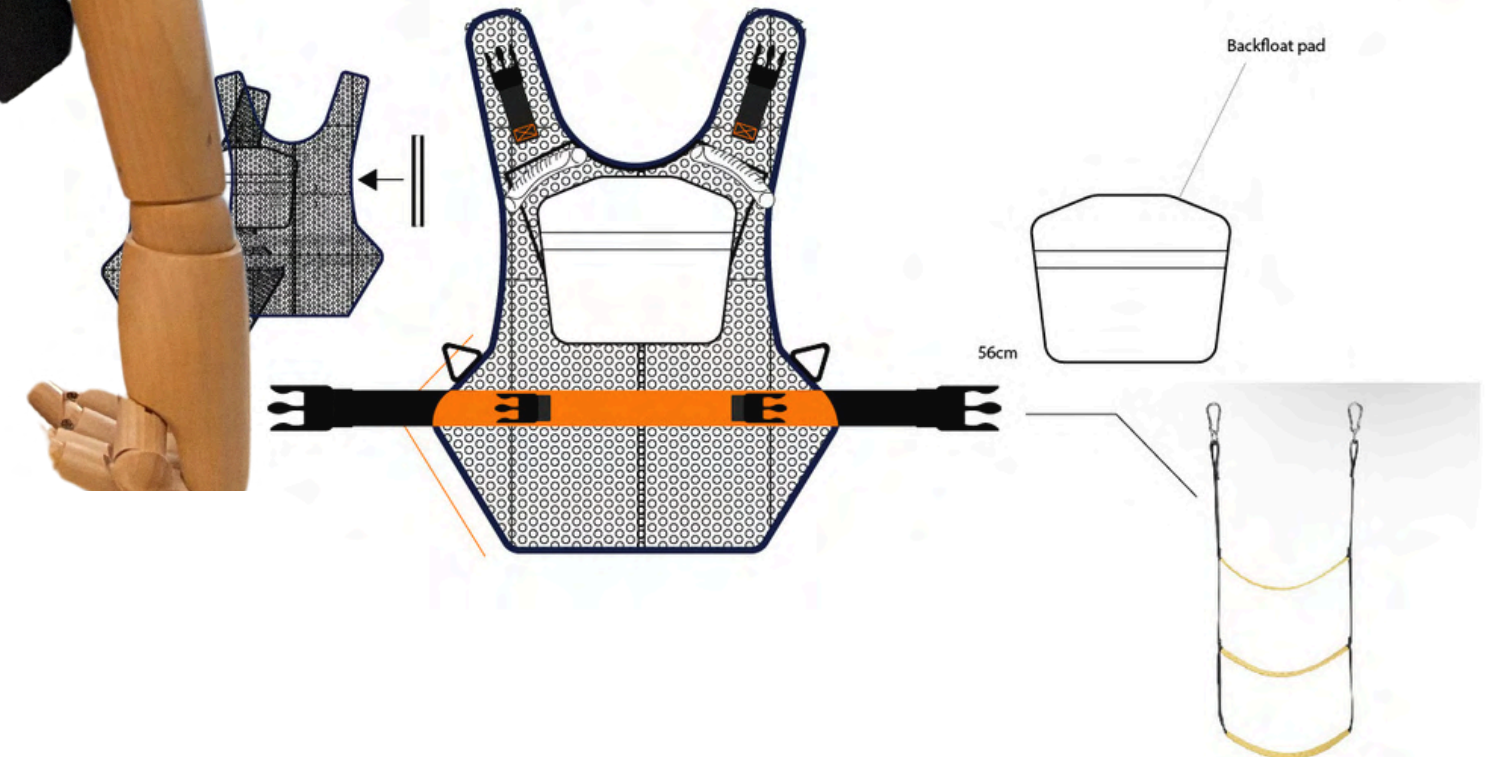



ATREOS
YOUR ENHANCED DINING EXPERIENCE

Radical
Innovation
2024
Product
Finalist



A meal packaging system that blends the elegance of hotel room service with the convenience of takeout.

DESIGN DIRECTION

QUALITY + EFFICIENCY IN PACKAGING



Preserve the **presentation + ritual**

Maintain the **efficiency + portability**

Structure Multi-item meals

Use **sustainable, disposable materials**

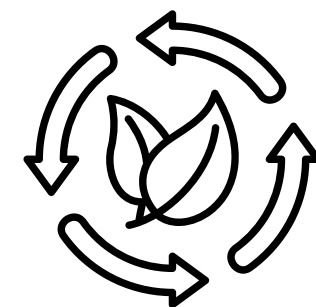
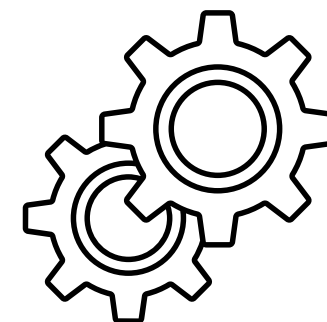
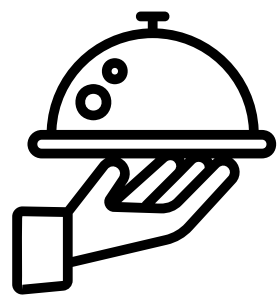

IDEATION

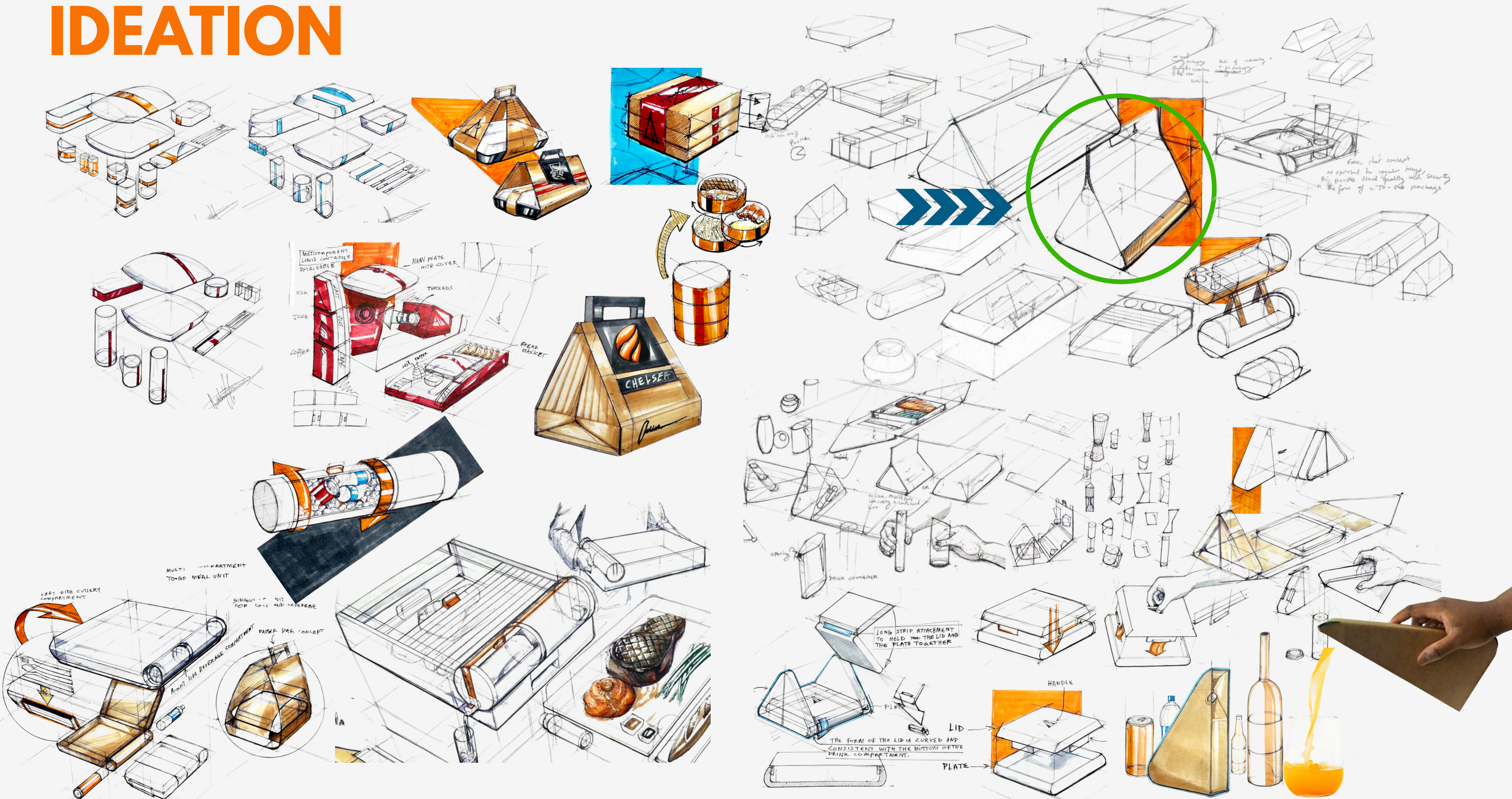

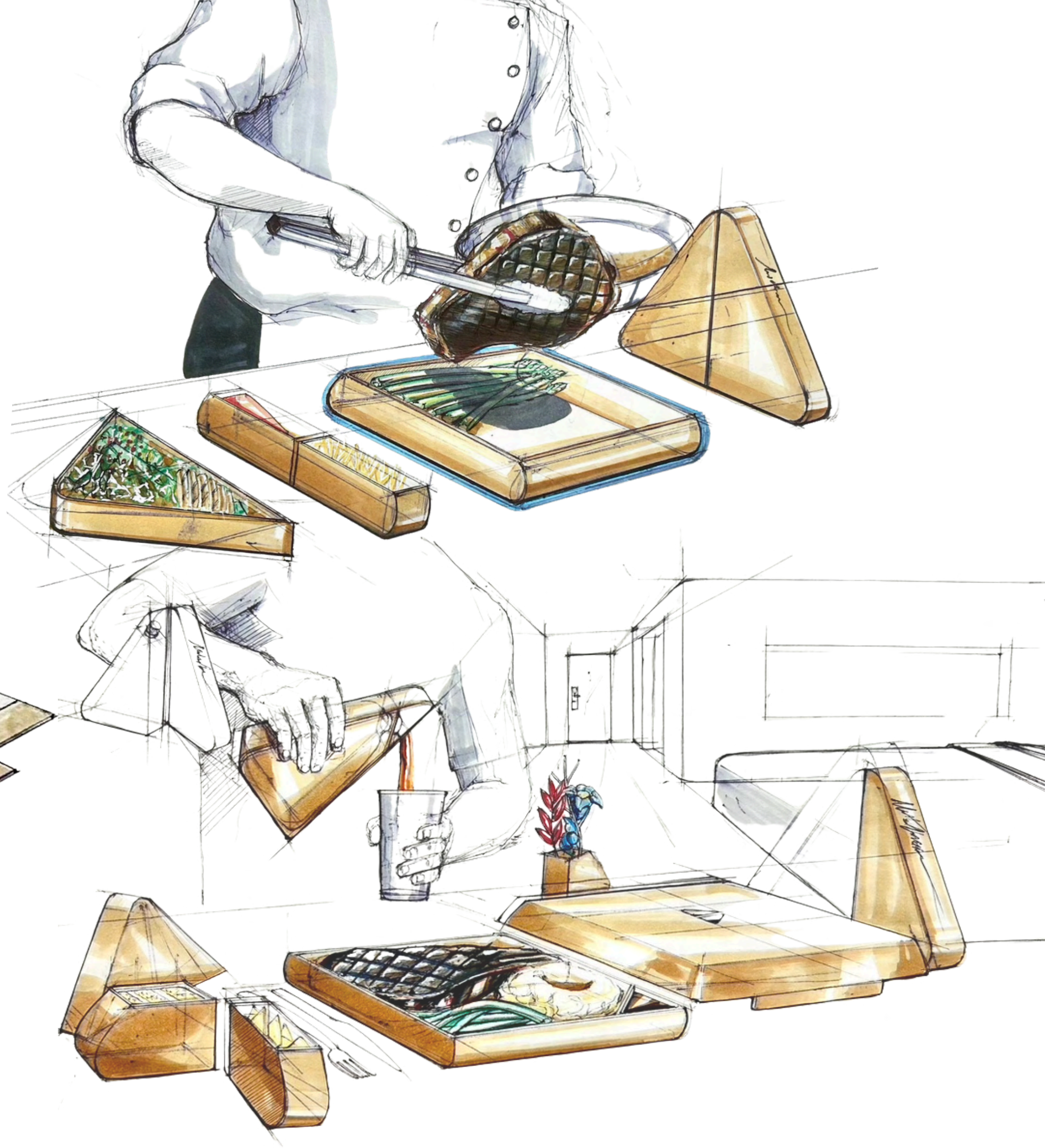
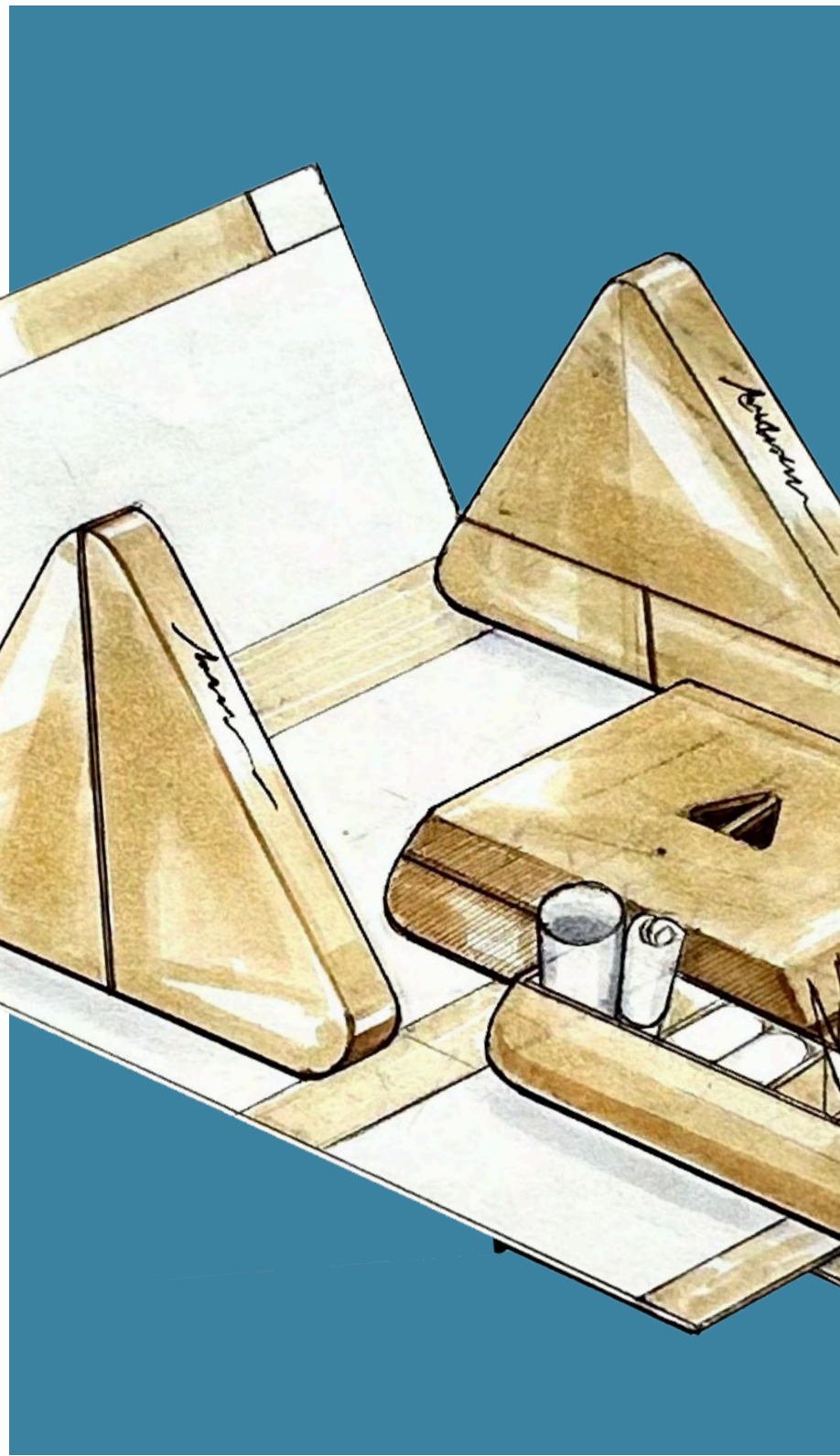

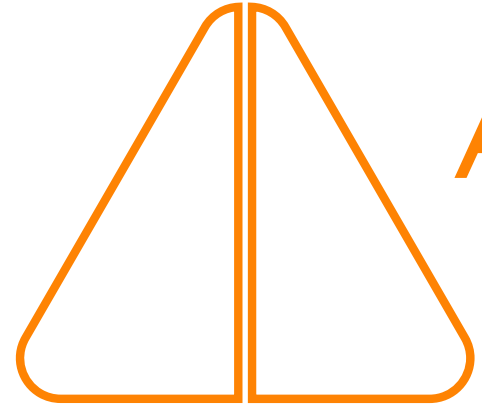

ATREOS





COLONNADE

Rotary Espresso station

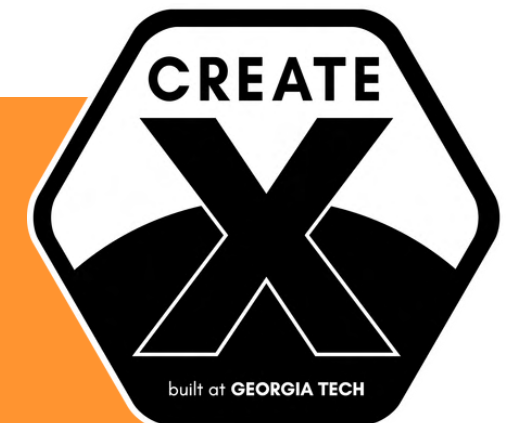

Accepted to Georgia Tech's CREATE-X Startup launch for Summer 2026 cohort

THE PROBLEM



BULKY

Most home espresso machines lack aesthetic elegance that adds beauty to the home and invites people to the experience

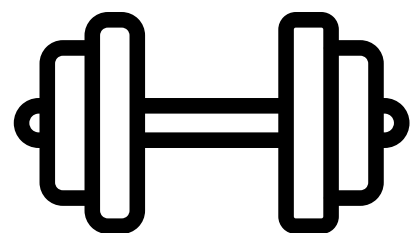

CLUTTERED

Machines and accessories create counter clutter and friction

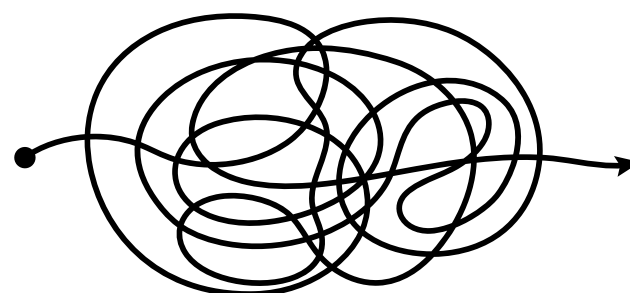

FRAGMENTED WORKFLOW

Brewing requires multiple tools across the counter, breaking the ritual

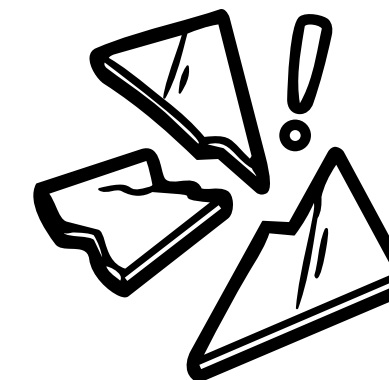

DESIGN DIRECTION



A centralized brewing station that transforms espresso preparation into a shared ritual.

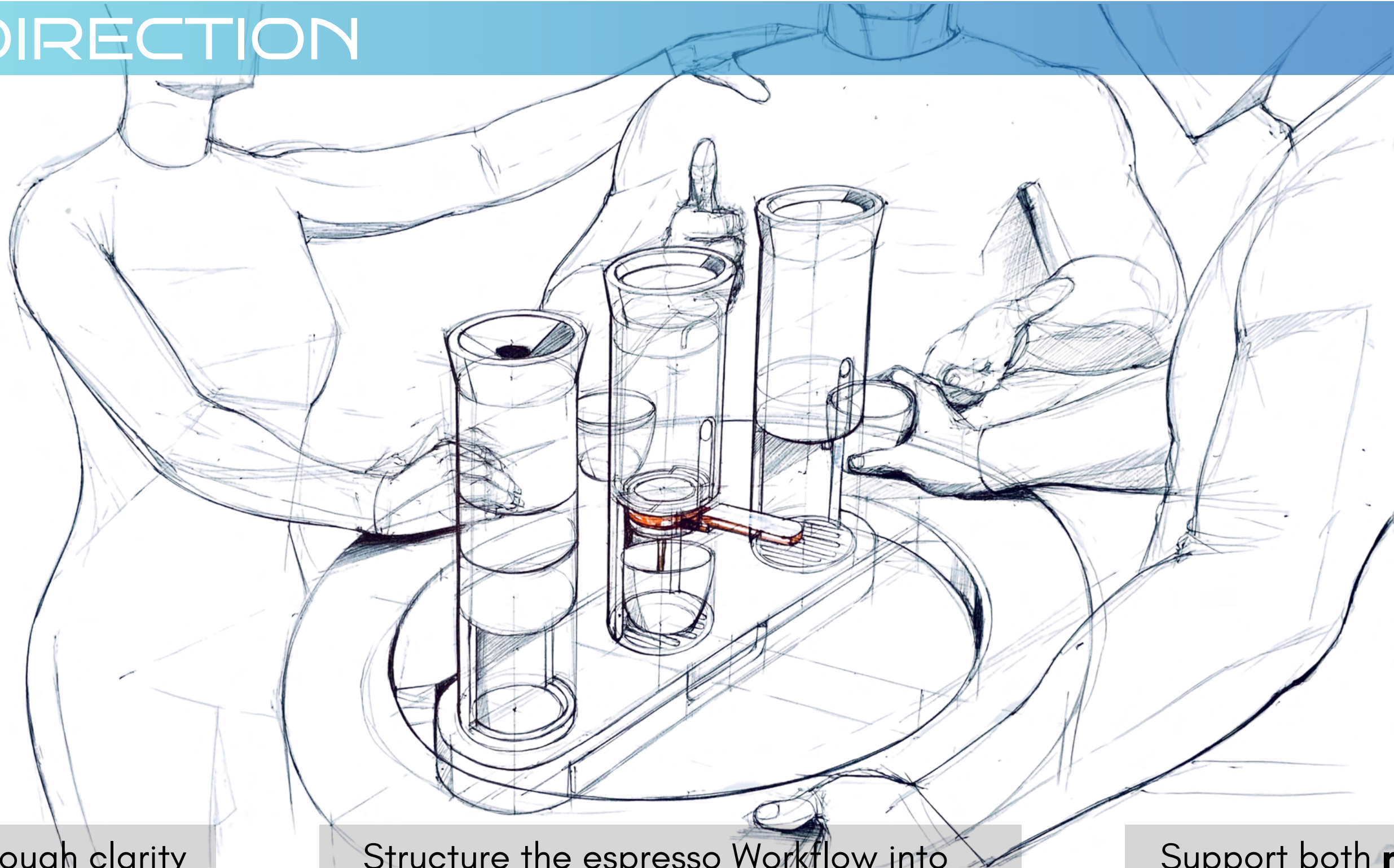

Invite interaction through clarity of form



Structure the espresso Workflow into **legible** and **organized** steps



Support both **ritual** and **shared experience**



IDEATION

IMMERSION IN CRAFT

Understanding the espresso ritual



600+
shots of espresso made



Refined Output



Raw extraction attempts:

Early extraction attempts revealed how grind size, pressure, and timing directly impact crema formation and consistency



GRINDER COLUMN
WITH VENTS FOR SENSORY EXPERIENCE



II. ESPRESSO COLUMN

III. MILK FROTH COLUMN

TURNTABLE

PORTAFILTERS

DRAIN PAN

Rotating Turntable and service station

CMF



BLACK
STAINLESS
STEEL

LEATHER

WALNUT
WOOD

BLACK
MARBLE

Three-Column Prep station

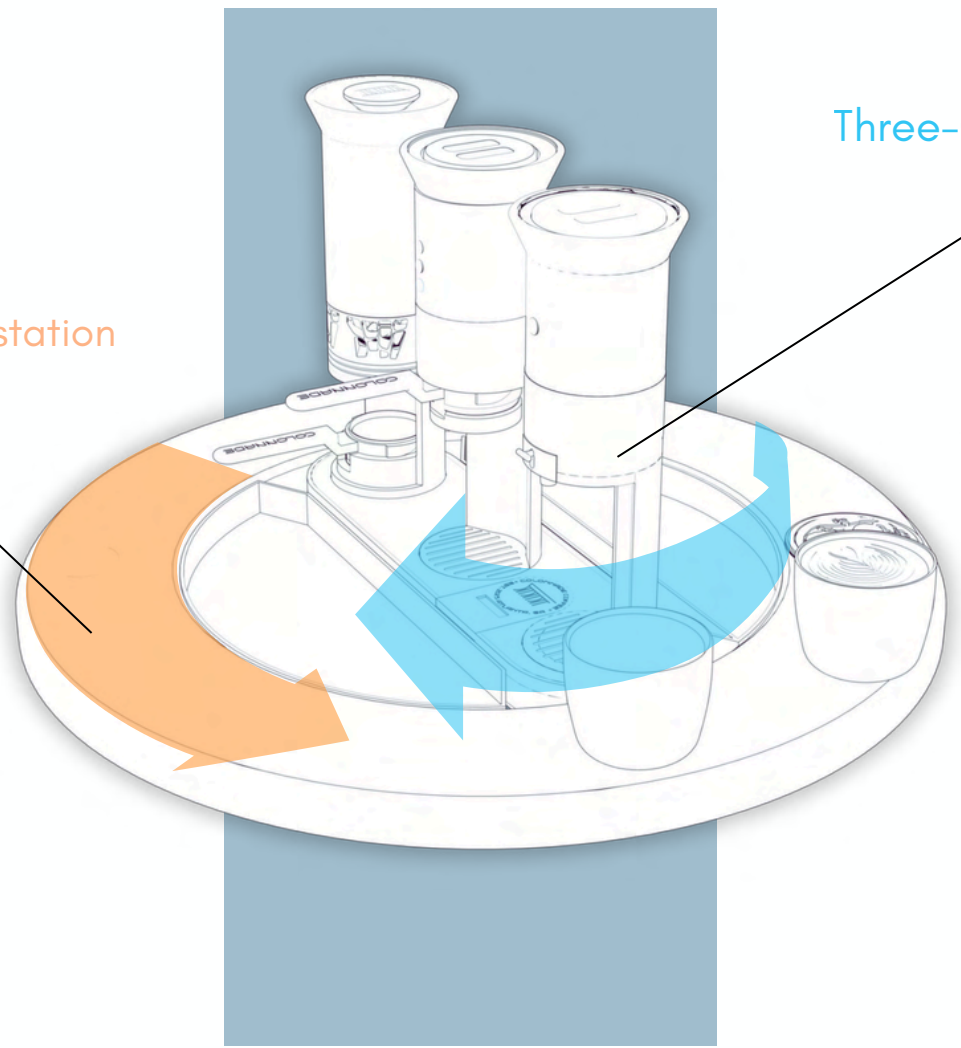

GRIND

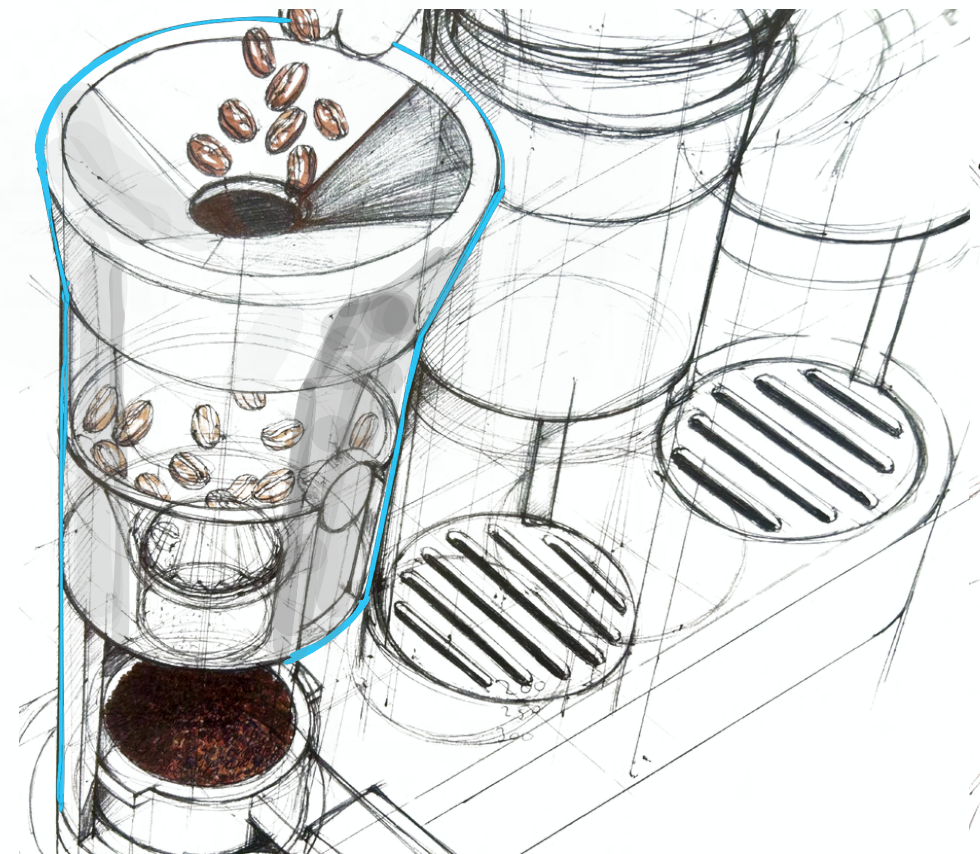

BREW

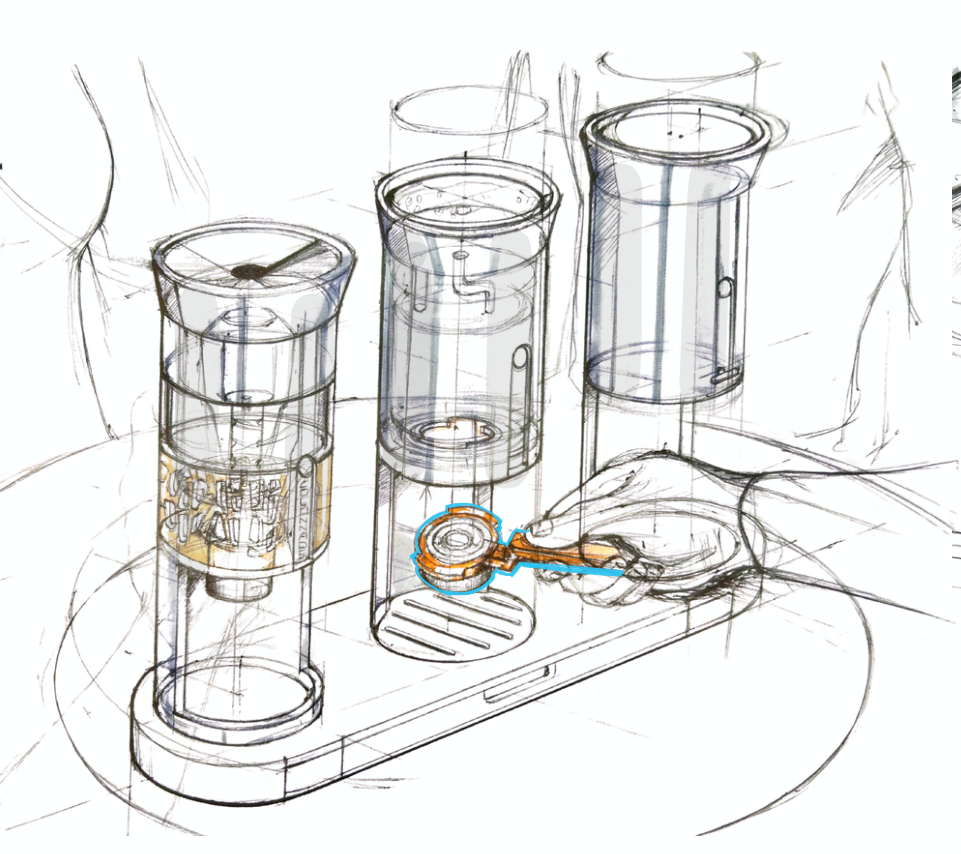

FROTH + POUR

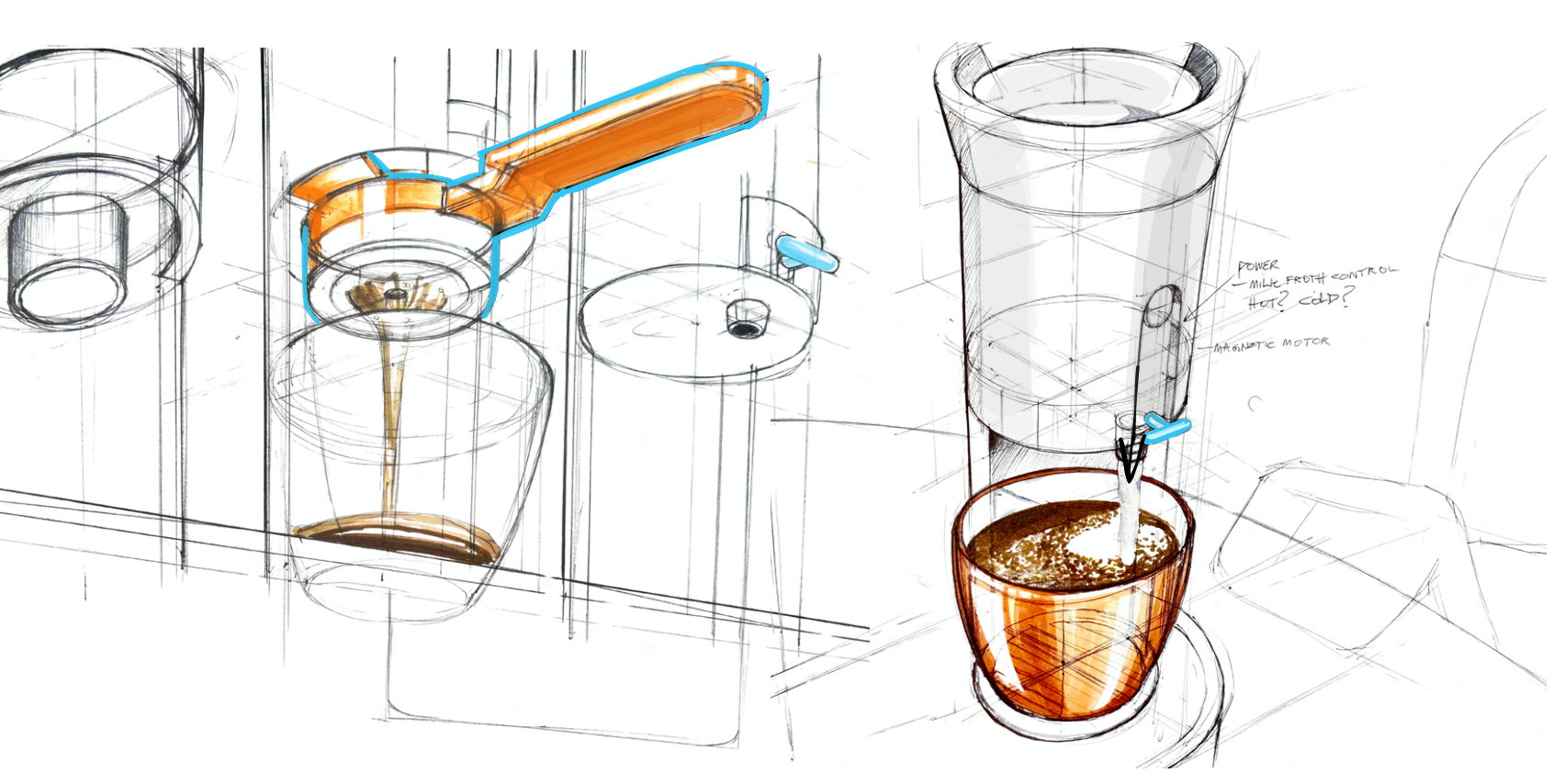

PROTOTYPES

DFM



Drawings generated on Fusion 360

